

**DAILY**  
THERMETRICS



# Thermocouples and RTDs

## Sensor Catalog



**DAILY THERMETRICS** is a single-source provider of superior temperature measurement systems and field services to make projects flow seamlessly from feasibility to construction. This unique capability allows **Daily** to provide design and technical support as well as control the fabrication and testing schedule to ensure timely, consistent delivery.

Since 1973, Daily Thermetrics Corporation has provided the process industries with the tools for process optimization through precise temperature measurement instrumentation. We are known for the highest quality equipment, turnkey services, and emergency delivery services to meet the demands of our customers. Daily Thermetrics owns multiple patents in the field of temperature sensing instrumentation and is committed to pushing the limits of conventional temperature control through constant research and development. Our patented CatTracker® catalyst tracking system leads the industry in vessel temperature profiling and is the first flexible thermocouple system certified as SIL 3 capable. Proprietary CatTracker® manufacturing techniques have provided the building blocks for other Daily Thermetrics exclusive products, including Daily Premium™ Line and EZPad™ replaceable skin thermocouples. Whatever the situation, from common thermocouple issues to complex hydrocracker catalyst profiling and fired heater issues, Daily Thermetrics' technical team is qualified to provide essential expertise and best-practice solutions. Throughout the refining, petrochemical, and power industries, Daily Thermetrics has provided thousands of plant operators with key process control data all over the world.



Manufacturing Headquarters  
Houston TX, USA

1. Daily Thermetrics' U.S. and worldwide patents include USPN 8,870,455; USPN 6,599,011; USPN 6,550,963; CA 2,848,398; and CA 2,449,074. Additional patents are pending.

# The **Daily** Advantage

Comprehensive Solutions for Your Temperature Needs

## PRODUCT LINES

- Thermocouples and RTDs
- Surface Temperature Measurement
- Vessel Thermometry
- Thermowells

## EXPERTISE

- Refinery-Wide Application Specialists
- Process Unit Specific Approach
- Proprietary Wake Frequency Analysis Software per ASME PTC 19.3 TW-2016 (available online)

## INSPECTION AND CERTIFICATION

Full Documentation and Traceability of In-House Testing including (but not limited to):

- Ultrasonic Inspection of Full Penetration Welds
- Radiographic Inspection of all Sensors
- Positive Material Identification (raw materials and finished products)
- Calibration Test (including cryogenic temperatures)
- ATEX and IEC Flameproof and Intrinsically Safe Certified Assemblies

## QUALITY CONTROL

- ISO 9001:2008 Certified
- Thermowell Serialization for Complete Traceability
- Climate and Contaminant Controlled Manufacturing Facility
- Level II Inspectors
- ASME section IX Qualified Welders

## SERVICE

- Turnkey and Supervisory Installation Services
- Site Turnaround (STAR™) Services
- Field Diagnostics & Application Consultation



# Thermocouples & Resistance Temperature Detectors (RTDs)

Daily Thermetrics understands that when it comes to replacing thermocouples and RTDs, it is not only the cost of the temperature sensor but also the costs and time involved in replacing the sensor. Every thermocouple and RTD supplied by Daily Thermetrics is designed and manufactured by Daily Thermetrics. Our cutting-edge manufacturing techniques and superior NDT practices ensure maximum sensor service life and performance.

Daily Thermetrics is the exclusive provider of the Daily Premium™ Line,<sup>1</sup> which utilizes the patented and certified SIL 3 capable CatTracker® technology. These thermocouples deliver measurable improvements in reliability and accuracy for temperature critical applications. As an added safety measure for hazardous area locations, Daily Thermetrics also manufactures Flameproof “d” rated assemblies carrying the IEC, ATEX, and TR/CU (GOST-R) certifications.<sup>2</sup> From simple probes to customized designs, every sensor is backed by our quality guarantee and made to order.

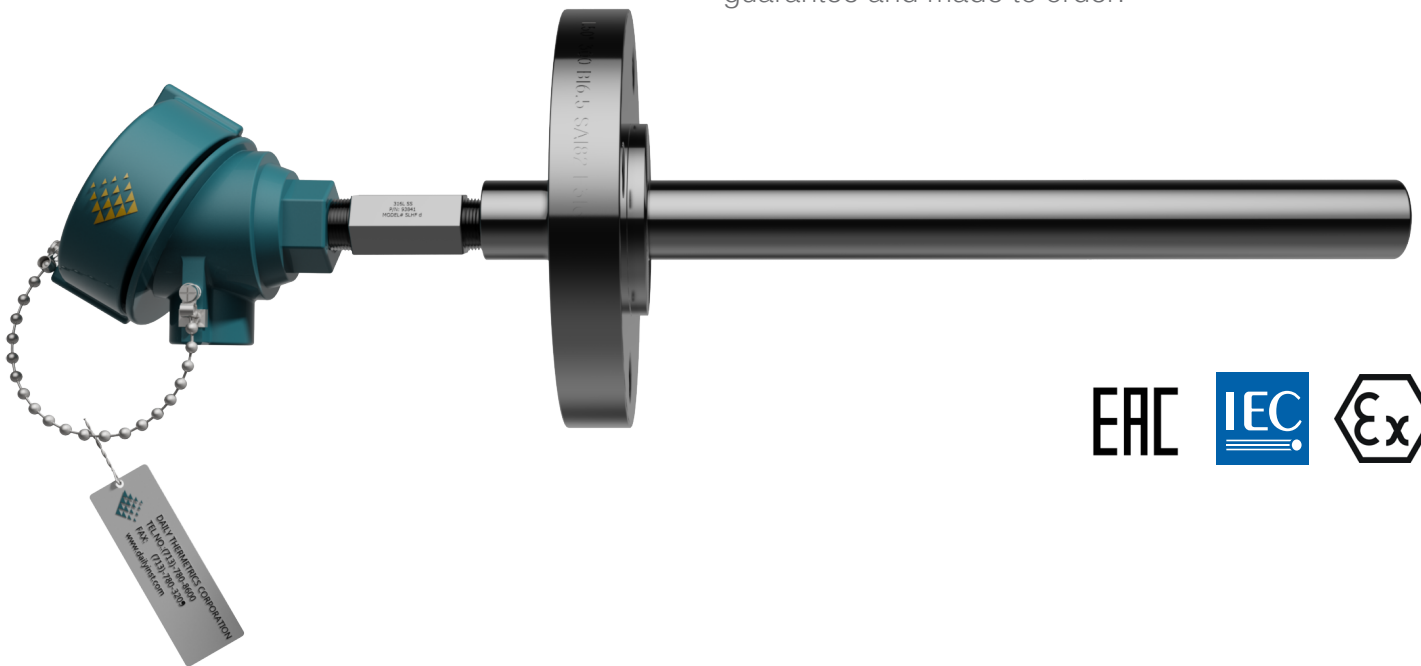

## Around-the-Clock Service

Emergency delivery situations commonly arise as a result of discovery during turnarounds. Daily Thermetrics is structured to support your turnaround needs by offering immediate service 24 hours a day, 7 days a week. No matter what time of day or night, a product specialist is always ready to assist you.

For all inquiries, please e-mail us at [sales@dailyinst.com](mailto:sales@dailyinst.com)

For emergency assistance, please call at +1 713.780.8600

1. Please see Page 17 for additional details.

2. Contact your local sales representative for additional details.



# Temperature Sensors

## Unique Features and Advantages

Daily Thermetrics performs X-ray inspection on 100% of thermocouples and RTDs as a standard. This inspection evaluates both the hot (sensing) junction and the transition housing to allow identification of critical issues and faults that would otherwise be undetectable utilizing standard electrical tests. The result is a sensor that has been truly vetted for severe service applications.

### X-RAY OF MEASURING JUNCTION

A concentric microfocus X-ray of the sensing junction is the only way to detect failures that are otherwise undetectable to the naked eye or standard electrical tests. This mitigates issues that will otherwise only appear once the element is installed in the field.

### X-RAY OF TRANSITION HOUSING

An X-ray of the transition housing verifies all wire transitions are strong and that good, uniform epoxy coverage is present. The transition housing protects the thermocouple from outside contaminants and corrosion.

### VACUUM EPOXY SEAL

Moisture in the insulating material is the leading cause of sensor drift and failure. The vacuum epoxy seal prevents moisture or other contaminants from penetrating the hygroscopic mineral insulation.

### SILVER-BRAZED TRANSITION HOUSING

Daily Thermetrics' housings are silver-brazed to the sensor sheath in lieu of the traditional pressure crimp. This joint is a full-circumferential seal that will not deteriorate over time due to thermocycling or stress.

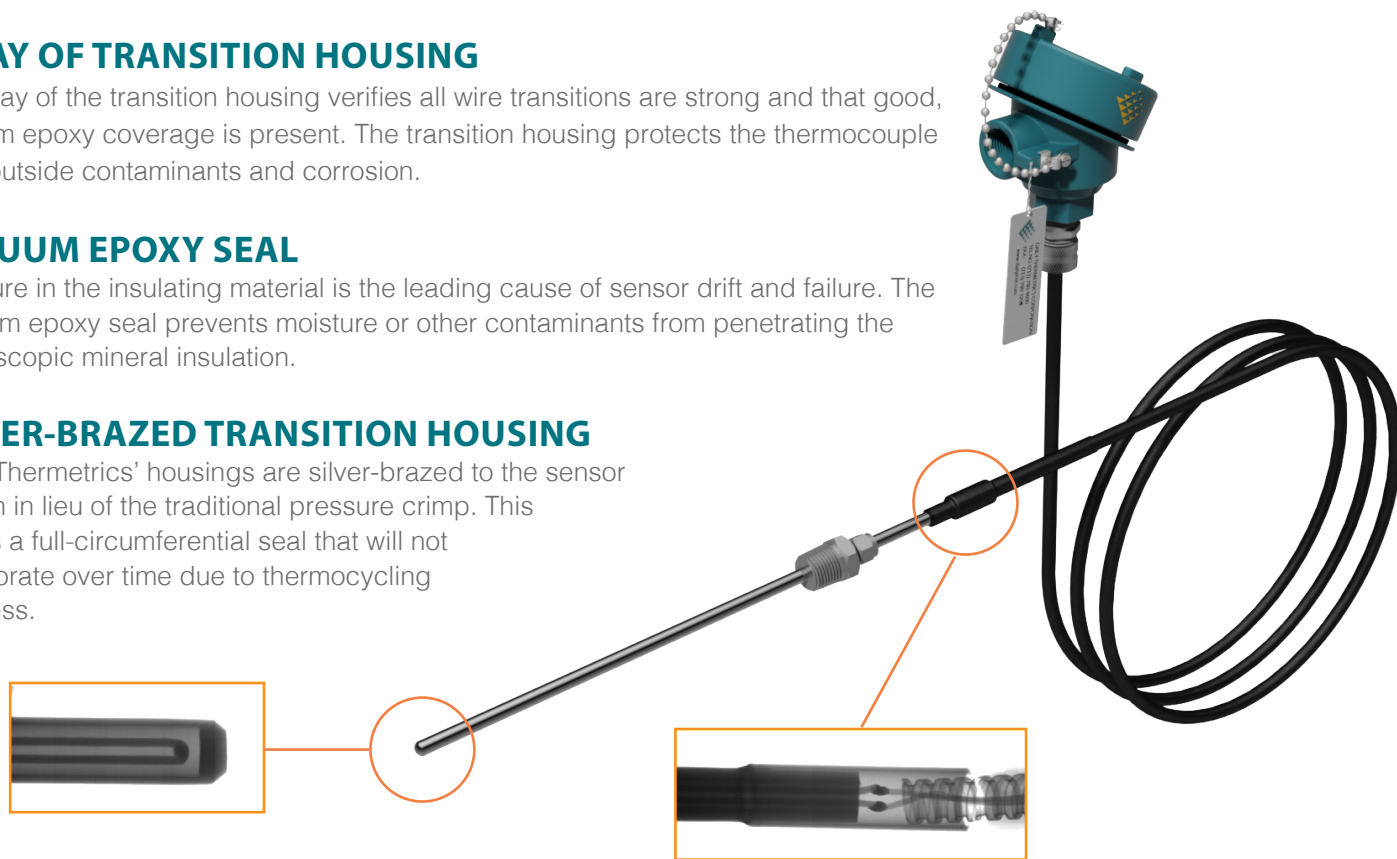

## Daily Thermetrics' advantages increase unit profitability by:

Tightened Process Control → Improved Yield / Conversion

Improved Reliability → Less Maintenance Required / No False Trips

Increased Safety → Confidence in Sensor Readings

# Sensor Options Guide

## Thermocouple and RTD Selection

Thermocouple Calibration	Sensor Metallurgy		Color Code		Temperature Range	Limits of Error (Accuracy)	
	Positive	Negative	Positive	Negative		Standard (whichever is greater)	Special (whichever is greater)
K	Chromel - NiCr	Alumel - NiAl	Yellow	Red	-328 to 32°F (-200 to 0°C)	±4.0°F (2.2°C) or ±.75%	N/A
					32 to 2300°F (0 to 1260°C)	±4.0°F (2.2°C) or ±.75%	±2.0°F (1.1°C) or ±.4%
J	Iron - Fe	Constantan - CuNi	White	Red	32 to 1400°F (0 to 760°C)	±4.0°F (2.2°C) or ±.75%	±2.0°F (1.1°C) or ±.4%
E	Chromel - NiCr	Constantan - CuNi	Purple	Red	-328 to 32°F (-200 to 0°C)	±3.1°F (1.7°C) or ±.1%	N/A
					32 to 1600°F (0 to 870°C)	±3.1°F (1.7°C) or ±.5%	±1.8°F (1.0°C) or ±.4%
T	Copper - Cu	Constantan - CuNi	Blue	Red	-328 to 32°F (-200 to 0°C)	±1.8°F (1.0°C) or ±1.5%	N/A
					32 to 700°F (0 to 370°C)	±1.8°F (1.0°C) or ±.75%	0.9°F (0.5°C) or ±.4%
S	Platinum - 10Rh	Platinum	Black	Red	32 to 2700°F (0 to 1480°C)	±2.7°F (1.5°C) or ±.25%	1.1°F (0.6°C) or ±.1%
R	Platinum - 13Rh	Platinum	Black	Red	32 to 2700°F (870 to 1480°C)	±2.7°F (1.5°C) or ±.25%	1.1°F (0.6°C) or ±.1%
B	Platinum - 30Rh	Platinum - 6Rh	Gray	Red	1600 to 3100°F (0 to 1700°C)	±.5%	±.25%
N	Nicrosil - Ni-Cr-Si	Nisil - Ni-Si-Mg	Orange	Red	32 to 2300°F (0 to 1260°C)	±4.0°F (2.2°C) or ±.75%	2.0°F (1.1°C) or ±.4%
RTD Calibration	Sensor Metallurgy	Number of Sensors	Color Code		Temperature Range	Tolerance Class Definitions	
			Positive	Negative		Class B (in °C)	Class A (in °C)
RTD - 100Ω PT, Alpha = 0.00385	Platinum	Single	White	Red	Low Temp -58 to 482°F (-50 to 250°C) High Temp -328 to 1221°F (-200 to 661°C)	±(0.3 + 0.005  t )	±(0.15 + 0.002  t )
		Dual	Yellow	Black			

## Sensor Calibration Selection

Upper temperature limits for various types and wire sizes in a closed-end protecting tube.  
*This does not apply to compacted mineral-insulated, metal-sheathed thermocouples.*

Thermocouple / RTD Type	Wire Gauge	Upper Temperature Limits	Conditions for Which Each is Best Suited
K	8 AWG	2300°F (1260°C)	The most common general purpose thermocouple. Suitable for use in oxidizing or neutral atmospheres. Recommended for use in temperature ranges of 1000°F to 2000°F. Accuracy below 900°F is greatly reduced after prolonged use above 1400°F. Should not be used in reducing atmospheres if unprotected.
	14 AWG	2000°F (1093°C)	
	20 AWG	1800°F (982°C)	
	24 AWG	1600°F (871°C)	
J	8 AWG	1400°F (760°C)	Has a more restricted range than Type K but a higher sensitivity. Suitable for use in reducing or neutral atmospheres. Because oxidation of the iron wire occurs rapidly at temperatures above 1000°F, the heavier gauge wires should be used at those temperatures. Iron wire may be attacked by ammonia, hydrogen, and nitrogen if not protected.
	14 AWG	1100°F (593°C)	
	20 AWG	900°F (482°C)	
	24 AWG	700°F (371°C)	
E	8 AWG	1600°F (871°C)	Has a high sensitivity and is well suited for cryogenic use. Recommended for use in oxidizing atmospheres. Exhibits good resistance to corrosion at low temperatures. Recommended for computer applications. Non-magnetic.
	14 AWG	1200°F (649°C)	
	20 AWG	1000°F (538°C)	
T	14 AWG	700°F (371°C)	Preferred type of thermocouple for cryogenic applications. Acceptable for mildly oxidizing or reducing atmospheres. High corrosive resistance to moisture and excellent for very low temperature applications.
	20 AWG	500°F (260°C)	
	24 AWG	400°F (204°C)	
S	24 AWG	2700°F (1482°C)	Type S is recommended only for higher temperature applications. Protection from all atmospheres must be provided, as they are subject to contamination and subsequent calibration drift. Commonly used for calibration.
R	24 AWG	2700°F (1482°C)	Type R is recommended only for higher temperature applications. Protection from all atmospheres must be provided, as they are subject to contamination and subsequent calibration drift. More sensitive and is used in industrial applications.
B	24 AWG	3100°F (1704°C)	Type B is recommended only for higher temperature applications. Protection from all atmospheres must be provided, as they are subject to contamination and subsequent calibration drift.
N	8 AWG	2300°F (1260°C)	Similar to Type K, but shows enhanced thermoelectric stability relative to Type K.
	14 AWG	2000°F (1093°C)	
	20 AWG	1800°F (982°C)	
	24 AWG	1600°F (871°C)	
RTD - 100Ω PT, ALPHA=0.00385	N/A	1221°F (660°C)	More accurate and stable than thermocouples but more fragile. Limited temperature range, sheath material, and size options.

# Sensor Options Guide

## Mineral-Insulated Metal-Sheath Material Selection Guide

Material	Recommended Maximum Operating Temperature	Remarks
304 SS	1600°F (871°C)	Widely used sheath material. Lowest cost corrosion resistant sheath material.
304L SS	1600°F (871°C)	Low carbon version of 304 SS. Reduces carbon precipitation at temperatures greater than 900°F range.
316 SS	1600°F (871°C)	Higher corrosion resistance than 304 SS. Most widely used thermocouple sheath material.
316L SS	1650°F (899°C)	Low carbon version of 316 SS. Increases weldability.
310 SS	2100°F (1149°C)	Best heat resistance of the stainless steels. Similar corrosion resistance to that of 304 SS. Suitable for sulfuric atmospheres.
321 SS	1600°F (871°C)	Titanium stabilized for intergranular corrosion resistance. Overcomes carbon precipitation at temperatures above 900°F range.
347 SS	1500°F (816°C)	Similar to 321 SS but uses Niobium and Tantalum instead of Titanium. Used in prolonged service at temperatures above 900°F range.
446 SS	2100°F (1149°C)	Good resistance to sulfur, nitric acid, and alkalis at high temperatures.
Inconel® 600	2150°F (1177°C)	Widely used thermocouple sheath material. Good in highly corrosive environments. Good strength and oxidation resistance at high temperatures. Do not use in presence of sulfur above 1000°F.
Incoloy® 800	2000°F (1093°C)	Better sulfur resistance than Inconel® 600. Commonly used in heater applications.
Hastelloy® X	2200°F (1204°C)	Superior high temperature strength with oxidation resistance. Resistant to reducing and neutral atmospheric conditions. Highest maximum temperature rating of available metal sheath materials.
Monel® 400	1000°F (538°C)	Good resistance to hydrofluoric acid, sulfuric acid, and hydrochloric acid.

## Mineral-Insulated Metal-Sheath Thermocouple Dimensions (Typical)

*These dimensions are for reference only. Please contact factory for more information.*

Diameter Ø	Standard Wall			Heavy Wall		
	Sheath Wall Thickness	Single Thermocouples	Dual Thermocouples	Sheath Wall Thickness	Single Thermocouples	Dual Thermocouples
		Wire OD - Ø	Wire OD - Ø		Wire OD - Ø	Wire OD - Ø
1/32" (0.0313")	0.004"	0.006"	N/A	N/A	N/A	N/A
1/16" (0.0625")	0.008"	0.012"	0.010"	0.015"	0.009"	N/A
1/8" (0.125")	0.016"	0.025"	0.020"	0.030"	0.017"	0.014"
3/16" (0.188")	0.024"	0.037"	0.030"	0.045"	0.0026"	0.0021"
1/4" (0.250")	0.032"	0.049"	0.040"	0.060"	0.035"	0.028"
5/16" (0.313")	0.040"	0.061"	0.050"	0.075"	0.043"	0.034"
3/8" (0.375")	0.048"	0.074"	0.060"	0.090"	0.052"	0.041"
1/2" (0.500")	0.064"	0.098"	0.080"	0.120"	0.069"	0.055"

# Thermocouple Selection

## Application Data

### GROUNDING JUNCTION

In this general purpose design, the conductor wires are welded directly into the end cap and are thoroughly protected. This results in very good heat transfer from the process and a fast response time. This junction is susceptible to electrical noise, which can affect readings, and faults in the insulation are more difficult to detect. This style is best suited for direct contact skin-sensing applications.

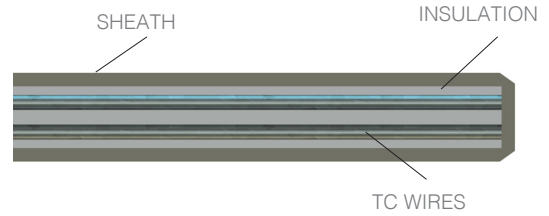

### UNGROUNDING JUNCTION

The sensing junction is electrically insulated from the external sheath with magnesium oxide. This type of junction has a moderate response time and is recommended where stray EMFs from electrical apparatuses could affect readings. Ungrounded junctions are also less susceptible to long-term drift under cycling conditions.

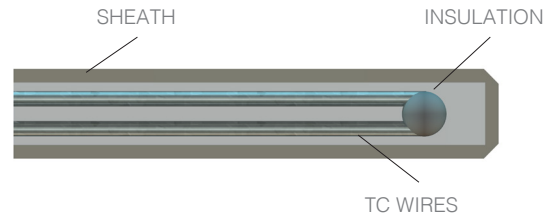

### EXPOSED JUNCTION

The sensing junction extends and is welded beyond the sheath, providing the fastest response. This type of junction should not be used in contaminating, high pressure, or particulate environments.

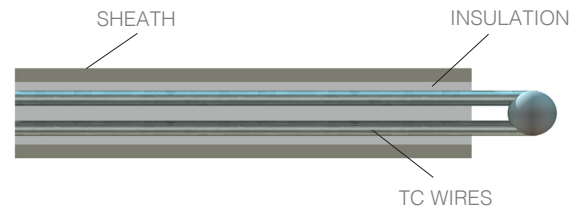



# Daily Thermetrics' Sensor Selection Guide

## Sensor Styles and Configurations

### MODEL 210 INDUSTRIAL SENSOR

See pages 9 – 10 for options and configurations

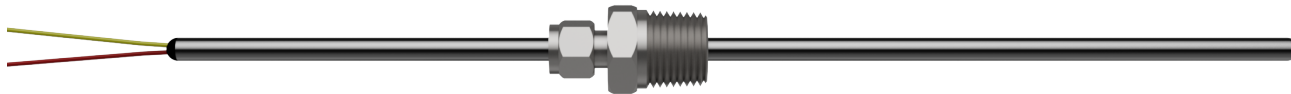

### MODEL 220 INDUSTRIAL SENSOR WITH FLEXIBLE LEADS

See pages 11 – 12 for options and configurations



### MODEL 310 INDUSTRIAL SENSOR ASSEMBLY

See pages 13 – 14 for options and configurations



### MODEL 360 INDUSTRIAL SENSOR ASSEMBLY WITH REMOTE HEAD

See pages 15 – 16 for options and configurations

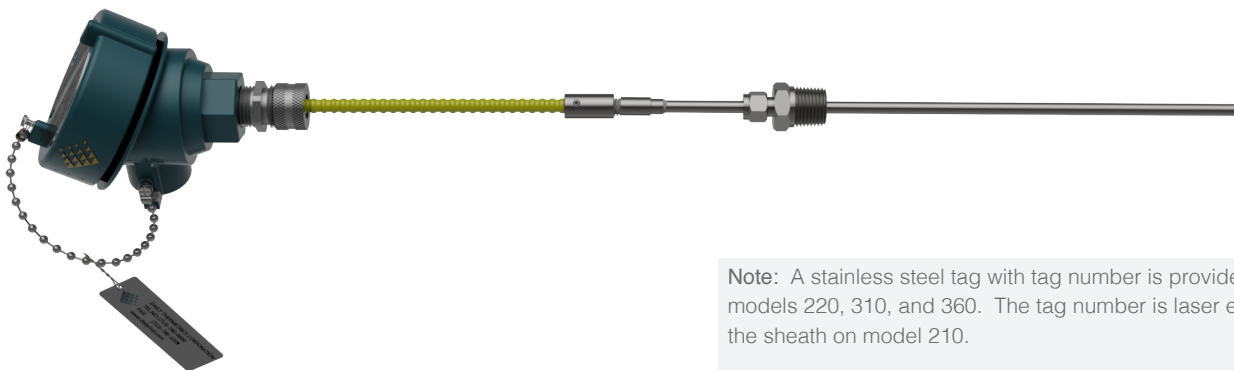

**Note:** A stainless steel tag with tag number is provided with models 220, 310, and 360. The tag number is laser etched into the sheath on model 210.

MODEL 210

MODEL 220

MODEL 310



MODEL 360



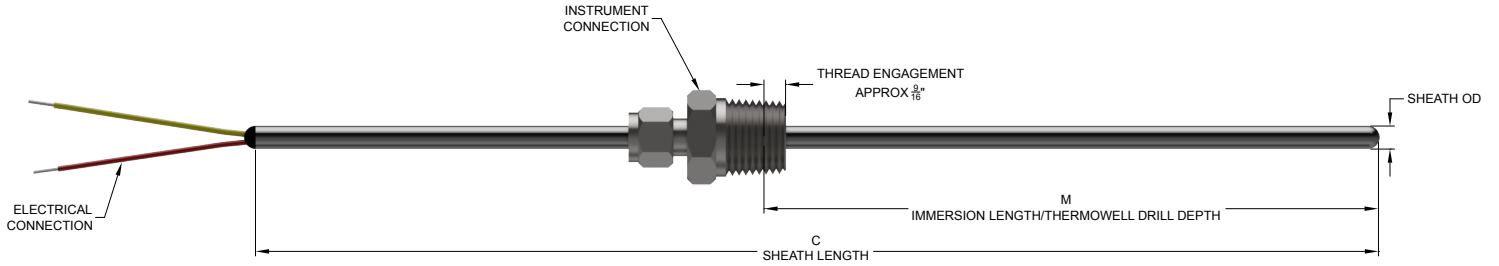

# Model 210

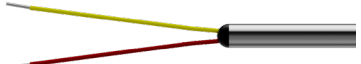
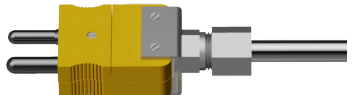
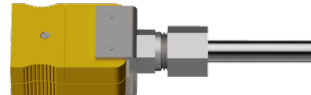
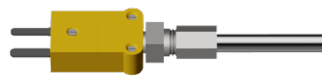
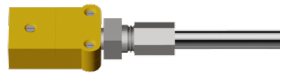
## Industrial Sensor

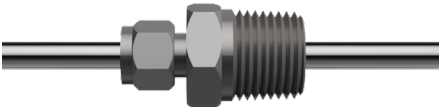

Daily Thermetrics' 210 Series Industrial Sensor is a basic mineral-insulated thermocouple / RTD probe with either bare leads or a connection plug for termination. This sensor is suited for use either in thermowells (see Daily Thermetrics' Thermowell Catalog) or directly in a process. All aspects of this sensor are customizable, including element type, sheath metallurgy, length, connection type, and termination style.

B	Electrical Connection Type
1	
Stripped Leads	
2	
Standard Plug	
3	
Standard Jack	
4	
Mini Plug	
5	
Mini Jack	
6	
Wafer	
7	
Plain End	

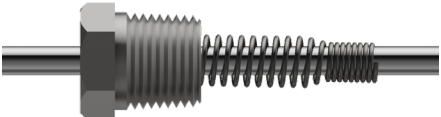
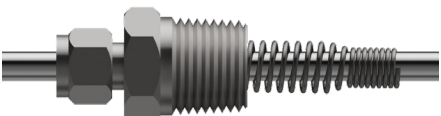
C	Instrument Connection Type
1 / 2 / 3	
Compression Fitting (Standard, Swagelok,® or Parker manufacturer)	
4 / 5	
Spring-Loaded Fitting with Retainer	
6 / 7	
Spring-Loaded Compression Fitting with Retainer	
8	
Welded Hex Nipple	
9	
Spring-Loaded Hex Nipple	
U / V	
Spring-Loaded Fitting with Self-Retaining Spring	
X / Y	
Spring-Loaded Compression Fitting with Self-Retaining Spring	

# Model 210 How to Order

EXAMPLE:

A	B	C	D	E	F	G	H	I	J	K	L	M	N	O	P
210	1	1	3	2	N	M6	C9	K	1	N	2	2	5	316	1

• INDICATES COMMON SELECTION

<b>A</b>	<b>Model</b>
210	Sensor •
<b>B</b>	<b>Electrical Connection Type</b>
1	Stripped Leads <sup>3</sup> •
2	Standard Plug
3	Standard Jack
4	Mini Plug
5	Mini Jack
6	Wafer Connector
7	Plain End
<b>C</b>	<b>Instrument Connection Type</b>
1	Compression Fitting •
2	Compression Fitting (Swagelok®)
3	Compression Fitting (Parker)
4	Spring-Loaded Fitting with SS Spring and Retainer
5	Spring-Loaded Fitting with Inconel® Spring and Retainer
6	Spring-Loaded Compression Fitting with SS Spring and Retainer
7	Spring-Loaded Compression Fitting with Inconel® Spring and Retainer
8	Welded Hex Nipple
9	Spring-Loaded Hex Nipple
U	Spring-Loaded Fitting with Self-Retaining SS Spring
V	Spring-Loaded Fitting with Self-Retaining Inconel® Spring
X	Spring-Loaded Compression Fitting with Self-Retaining SS Spring
Y	Spring-Loaded Compression Fitting with Self-Retaining Inconel® Spring
N	None •
<b>D</b>	<b>Instrument Connection Size</b>
1	3/8" NPT
2	1/2" NPT •
3	3/4" NPT
N	None •
<b>E</b>	<b>Instrument Connection Material</b>
1	304 SS
2	316 SS •
3	Brass
N	None •
<b>F</b>	<b>Vent Hole for Instrument Connection - Ø1/8"</b>
Y	Yes
N	None •
<b>G</b>	<b>M Dimension (Immersion Length/Thermowell Drill Depth)</b>
M0	No Instrument Connection (or set length in field) •
M6	6" •
M9	9" •
M12	12" •
M15	15" •
M18	18" •
MXX	Custom Length (specify in inches)
<b>H</b>	<b>C Dimension (Sheath Length)</b>
CS	Standard ("M" + 3") •
CXX	Custom Length (specify in inches)
<b>I</b>	<b>Calibration (See Page 5)</b>
K	Type K - Thermocouple •
J	Type J - Thermocouple •
E	Type E - Thermocouple •
T	Type T - Thermocouple
S	Type S - Thermocouple
R	Type R - Thermocouple
B	Type B - Thermocouple
N	Type N - Thermocouple
L	Low Temp (-58°F to 482°F) - RTD •
H	High Temp (-328°F to 1221°F) - RTD •

<b>J</b>	<b>Sensor Type</b>
1	Single Thermocouple •
2	Duplex Thermocouple •
3	Triplex Thermocouple
A	2-Wire RTD, Single Element
B	3-Wire RTD, Single Element •
C	4-Wire RTD, Single Element
D	2-Wire RTD, Duplex Element (4 Wires Total)
E	3-Wire RTD, Duplex Element (6 Wires Total) •
F	4-Wire RTD, Duplex Element (8 Wires Total)
<b>K</b>	<b>Upgrade to Daily Premium™ Line</b>
Y	Yes (see page 17 for details as not all configurations are available) •
N	No (not available for RTDs) •
<b>L</b>	<b>Measuring Junction (See Page 7)</b>
1	Grounded •
2	Ungrounded •
3	Exposed
N	Not Applicable - RTD •
<b>M</b>	<b>Limits of Error (See Page 5)</b>
1	Standard Limits Thermocouple (Class 2) •
2	Special Limits Thermocouple (Class 1) <sup>4</sup> •
A	100 OHM Platinum, Alpha=0.00385 (Class A) RTD
B	100 OHM Platinum, Alpha=0.00385 (Class B) RTD •
<b>N</b>	<b>Sensor Sheath Diameter (See Page 6)</b>
1	1/16" (0.0625")
2	1/8" (0.125") <sup>5</sup>
3	3/16" (0.188") <sup>6</sup>
4	1/4" (0.250") <sup>6</sup> •
5	5/16" (0.313") <sup>6</sup>
6	3/8" (0.375") <sup>6</sup> •
7	1/2" (0.500") <sup>6</sup>
<b>O</b>	<b>Sensor Sheath Material (See Page 6)</b>
304	304 SS
304L	304L SS
316	316 SS <sup>7</sup> •
316L	316L SS
310	310 SS
321	321 SS
347	347 SS
446	446 SS
1600	Inconel® 600 •
1800	Incoloy® 800
HASTX	Hastelloy® X
M400	Monel® 400
<b>P</b>	<b>Calibration Options</b>
1	Report not Required •
2	212°F (100°C) with Certificate •
3	212°F (100°C) with Report
4	3-Point Calibration <sup>8</sup> with Report
5	5-Point Calibration <sup>8</sup> with Report





1. A unique and simplified item number will be generated and issued to every customized thermocouple for ease of reordering.
2. The majority of options are customizable. Please contact sales if your requirements are not listed in this catalog.
3. 3" of stripped leads are provided. For longer leads refer to Model 220 with a flush transition housing.
4. Includes Daily Premium™ Line.
5. Low Temp RTD is available at 1/8" and bigger.
6. High Temp RTD is available at 3/16" and bigger.
7. 316 SS is standard for RTDs.
8. Specify calibration temperature points with order.

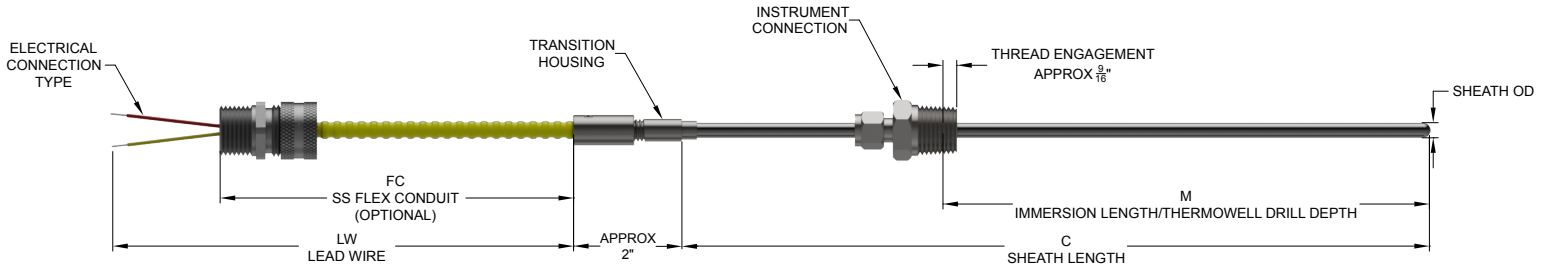

# Model 220

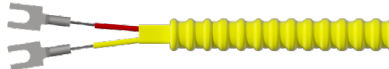
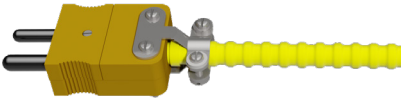

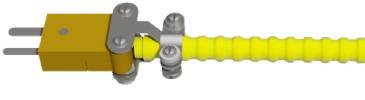
## Industrial Sensor with Flexible Leads



Daily Thermetrics' 220 Series Industrial Sensor with Flexible Leads is a sensor probe with conductor wires that transition into lead wire in flexible conduit for remote termination. This sensor is suited for use either in thermowells (see Daily Thermetrics' Thermowell Catalog) or directly in a process. All aspects of this sensor are customizable, including element type, sheath metallurgy, length, connection type, and termination style.

B	Electrical Connection Type
1	
Plain Leads	
2	
Spade	
3	
Standard Plug	
4	
Standard Jack	
5	
Mini Plug	
6	
Mini Jack	

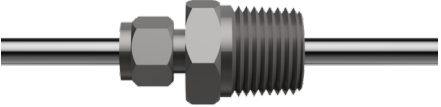
J	Transition Housing
1	
Housing with Adapter	
2	
Housing without Adapter	
3	
Flush	

K	Instrument Connection Type
1 / 2 / 3	
Compression Fitting (Standard, Swagelok® or Parker manufacturer)	
4 / 5	
Spring-Loaded Fitting with Retainer	
6 / 7	
Spring-Loaded Compression Fitting with Retainer	

\* Other Instrument Connection Types are shown on page 9

# Model 220 How to Order

EXAMPLE:

A	B	C	D	E	F	G	H	I	J	K	L	M	N	O	P	Q	R	S	T	U	V	W	X
220	1	1	1	4	1	2	FC36	LW39	1	1	3	2	N	M0	C12	K	2	N	1	1	5	316	1

• INDICATES COMMON SELECTION

A	Model	K	Instrument Connection Type	R	Sensor Type
220	Sensor with Flexible Leads •	1	Compression Fitting •	1	Single Thermocouple •
		2	Compression Fitting (Swagelok®)	2	Duplex Thermocouple •
		3	Compression Fitting (Parker)	3	Triplex Thermocouple
		4	Spring-Loaded Fitting with SS Spring and Retainer	A	2-Wire RTD, Single Element
		5	Spring-Loaded Fitting with Inconel® Spring and Retainer	B	3-Wire RTD, Single Element •
		6	Spring-Loaded Compression Fitting with SS Spring and Retainer	C	4-Wire RTD, Single Element
		7	Spring-Loaded Compression Fitting with Inconel® Spring and Retainer	D	2-Wire RTD, Duplex Element (4 Wires Total)
		U	Spring-Loaded Fitting with Self-Retaining SS Spring	E	3-Wire RTD, Duplex Element (6 Wires Total) •
		V	Spring-Loaded Fitting with Self-Retaining Inconel® Spring	F	4-Wire RTD, Duplex Element (8 Wires Total)
		X	Spring-Loaded Compression Fitting with Self-Retaining SS Spring		
		Y	Spring-Loaded Compression Fitting with Self-Retaining Inconel® Spring	S	Upgrade to Daily Premium™ Line
		N	None •	Y	Yes - (see page 17 for details as not all configurations are available) •
				N	No - RTD is not available in premium line •
				T	Measuring Junction (See Page 7)
				1	Grounded •
				2	Ungrounded •
				3	Exposed
				N	Not Applicable - RTD •
				U	Limits of Error (See Page 5)
				1	Standard Limits Thermocouple (Class 2) •
				2	Special Limits Thermocouple (Class 1) <sup>5</sup> •
				A	100 OHM Platinum, Alpha=0.00385 (Class A) RTD
				B	100 OHM Platinum, Alpha=0.00385 (Class B) RTD •
				V	Sensor Sheath Diameter (See Page 6)
				1	1/16" (0.0625")
				2	1/8" (0.125") <sup>6</sup>
				3	3/16" (0.188") <sup>7</sup>
				4	1/4" (0.250") <sup>7</sup> •
				5	5/16" (0.313") <sup>7</sup>
				6	3/8" (0.375") <sup>7</sup> •
				7	1/2" (0.500") <sup>7</sup>
				W	Sensor Sheath Material (See Page 6)
				304	304 SS
				304L	304L SS
				316	316 SS <sup>8</sup>
				316L	316L SS
				310	310 SS
				321	321 SS
				347	347 SS
				446	446 SS
				1600	Inconel® 600 •
				1800	Incoloy® 800
				HASTX	Hastelloy® X
				M400	Monel® 400
				X	Calibration Options
				1	Report not Required •
				2	212°F (100°C) with Certificate •
				3	212°F (100°C) with Report
				4	3-Point Calibration <sup>9</sup> with Report
				5	5-Point Calibration <sup>9</sup> with Report

B	Electrical Connection Type	L	Instrument Connection Type
1	Plain Leads •	1	3/8" NPT
2	Spade Lugs	2	1/2" NPT •
3	Standard Plug	3	3/4" NPT
4	Standard Jack	N	None •
5	Mini Plug	M <th>Instrument Connection Material</th>	Instrument Connection Material
6	Mini Jack	1	304 SS
		2	316 SS •
		3	Brass
		N	None •
		N <th>Vent Hole for Instrument Connection - Ø1/8"</th>	Vent Hole for Instrument Connection - Ø1/8"
		Y	Yes
		N	None •
		O <th>M Dimension (Immersion Length/Thermowell Drill Depth)</th>	M Dimension (Immersion Length/Thermowell Drill Depth)
		M0	No Instrument Connection (or set length in field) •
		M6	6" •
		M9	9" •
		M12	12" •
		M15	15" •
		M18	18" •
		MXX	Custom Length (specify in inches)
		P <th>C Dimension (Sheath Length)</th>	C Dimension (Sheath Length)
		CS	Standard ("M" + 3") •
		CXX	Custom Length (specify in inches)
		Q <th>Calibration (See Page 5)</th>	Calibration (See Page 5)
		K	Type K - Thermocouple •
		J	Type J - Thermocouple •
		E	Type E - Thermocouple •
		T	Type T - Thermocouple
		S	Type S - Thermocouple
		R	Type R - Thermocouple
		B	Type B - Thermocouple
		N	Type N - Thermocouple
		L	Low Temp (-58°F to 482°F) - RTD •
		H	High Temp (-328°F to 1221°F) - RTD •

  

C	Optional Conduit Adapter (Not Available with Plug and Jack Connections)	D	Conduit Adapter Material
1	1/2" NPT •	1	Aluminum •
2	3/4" NPT	2	Steel
N	None	N	Not Applicable
		E <th>Type of Lead Wire</th>	Type of Lead Wire
		1	Solid - 24 AWG
		2	Solid - 20 AWG
		3	Solid - 18 AWG
		4	Stranded - 24 AWG (standard for duplex thermocouples) •
		5	Stranded - 22 AWG (standard for RTDs)
		6	Stranded - 20 AWG (standard for single thermocouples) •
		F <th>Lead Wire Insulation</th>	Lead Wire Insulation
		1	PVC Coated ANSI MC 96.1 Color Code (-40°F to 221°F) (standard for Thermocouples) •
		2	PVC Coated IEC 584-3 Color Code (-40°F to 221°F)
		3	PFA Teflon Coated (-450° to 500°F) (standard for RTDs) •
		4	Fiberglass (-100° to 900°F)
		G <th>Flexible Conduit</th>	Flexible Conduit
		1	None
		2	PVC Coated Stainless Steel ANSI MC 96.1 Color Code (-40°F to 221°F) •
		3	PVC Coated Stainless Steel IEC 584-3 Color Code (-40°F to 221°F)
		4	PFA Teflon Coated Stainless Steel (-450° to 500°F)
		5	Stainless Steel with No Insulation
		H <th>FC Dimension (Flexible Conduit Length)</th>	FC Dimension (Flexible Conduit Length)
		FC36	36" •
		FCN	None
		FCXX	Custom Length (specify in inches)
		I <th>LW Dimension<sup>3</sup> (Lead Wire Length)</th>	LW Dimension <sup>3</sup> (Lead Wire Length)
		LW39	39" •
		LWXX	Custom Length (specify in inches) (minimum FC + 3")
		J <th>Transition Housing</th>	Transition Housing
		1	Housing with Adapter •
		2	Housing without Adapter
		3	Flush <sup>4</sup>

1. A unique and simplified item number will be generated and issued for every customized thermocouple for ease of reordering.
2. The majority of options are customizable. Please contact sales if your requirements are not listed in this catalog.
3. Lead wire length is the same as flexible conduit length if a plug or jack is selected. Otherwise, lead wire length will extend a minimum of 3" past the flexible conduit.
4. Cannot be used with flexible conduit, and diameter of sheath must be greater than 3/16".
5. Includes Daily Premium™ Line.
6. Low Temp RTD is available at 1/8" and bigger.
7. High Temp RTD is available at 3/16" and bigger.
8. 316 SS is standard for RTDs.
9. Specify calibration temperature points with order.

# Model 310

## Industrial Sensor Assembly

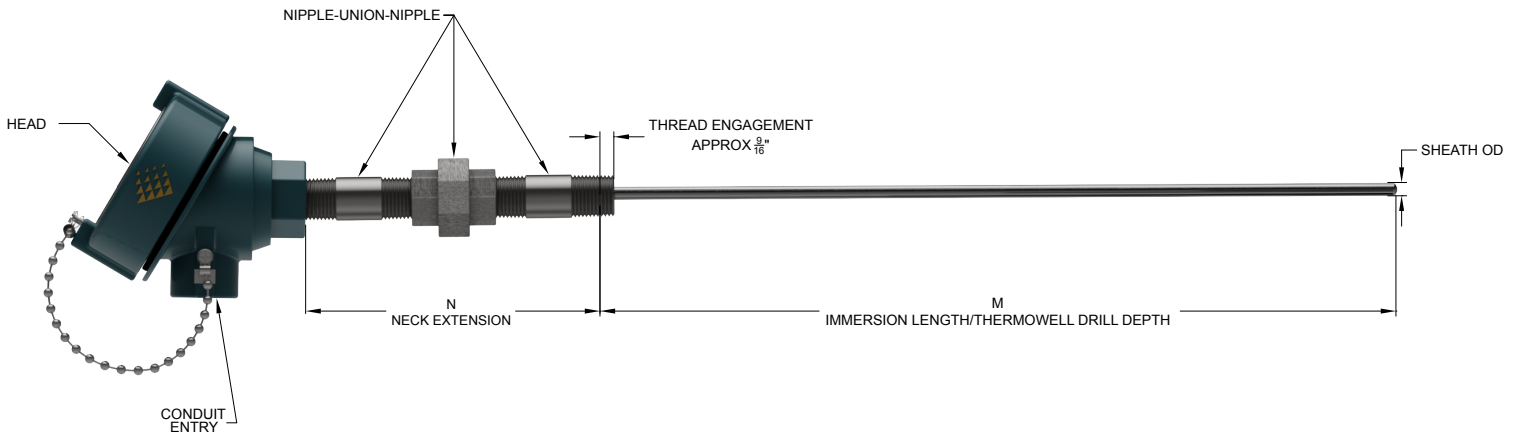

Daily Thermometrics' 310 Series Industrial Sensor Assembly is designed for direct termination into a head via a nipple and union combination. This style can be spring-loaded. This sensor is best suited for use with a thermowell (see Daily Thermometrics' Thermowell Catalog). All aspects of this sensor assembly are customizable, including element type, sheath metallurgy, length, connection type, and head.

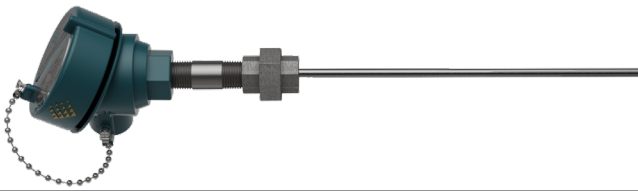
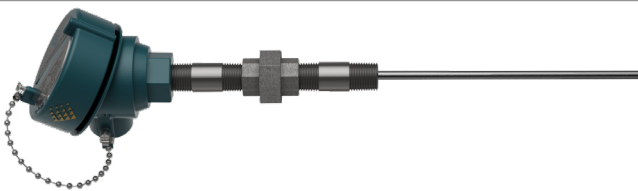
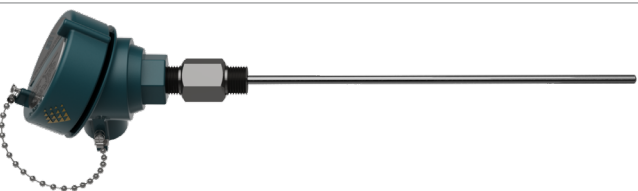
<b>B</b>	<b>Extension Type</b>
1	
Head and Nipple	
2	
Head, Nipple, and Union	
3	
Head, Nipple, Union, and Nipple	
4 / 5	
Head and Hex Nipple (Welded* or Spring-Loaded) <small>* Welded design can be used without thermowell</small>	

# Model 310 How to Order

EXAMPLE:

<b>A</b>	<b>B</b>	<b>C</b>	<b>D</b>	<b>E</b>	<b>F</b>	<b>G</b>	<b>H</b>	<b>I</b>	<b>J</b>	<b>K</b>	<b>L</b>	<b>M</b>	<b>N</b>	<b>O</b>	<b>P</b>	<b>Q</b>
310	3	1	1	1	N5	1	1	M9	K	1	N	2	2	5	316	1

• INDICATES COMMON SELECTION

<b>A</b>	<b>Model</b>
310	Sensor with Direct Mount Head •

<b>B</b>	<b>Extension Type</b>
1	Head and Nipple
2	Head, Nipple, and Union
3	Head, Nipple, Union, and Nipple •
4	Head and Welded Hex Nipple
5	Head and Spring-Loaded Hex Nipple

<b>C</b>	<b>Head Style &amp; Material</b>	<b>Classification</b>
1	Aluminum Explosion Proof (screw cover)	Cl I, Div 1, Groups B,C,D NEMA 4X, IP68, Ex d ATEX, IEC, CSA, FM •
2	Aluminum Weatherproof (snap cover)	Not Applicable
3	Cast Iron Explosion Proof (screw cover)	Cl I, Div 1&2, Groups B,C,D NEMA 3, 4, 7CD, 9EFG
4	Cast Iron Weatherproof (screw cover)	Not Applicable

<b>D</b>	<b>Conduit Entry</b>
1	3/4" FNPT •
2	1/2" FNPT
3	1" FNPT
4	M20x1.5

<b>E</b>	<b>Instrument Connection</b>
1	1/2" NPT •
2	3/8" NPT
3	3/4" NPT
4	1" NPT

<b>F</b>	<b>N Dimension (Neck Extension Length)</b>
N2	2" (standard for Head & Nipple assemblies) •
N5	5" (standard for Head, Nipple, & Union assemblies and Head, Nipple, Union, & Nipple assemblies) •
NXX	Custom Length (specify in inches)

<b>G</b>	<b>Neck Extension Material</b>
1	Galvanized Steel •
2	304 SS
3	316 SS •

For Flameproof Options, Contact Sales

<b>H</b>	<b>Spring-Loading Material</b>
1	SS Spring •
2	Inconel® Spring
3	Not Spring-Loaded For Welded Hex Nipple

<b>I</b>	<b>M Dimension (Immersion Length/Thermowell Drill Depth)</b>
M6	6" •
M9	9" •
M12	12" •
M15	15" •
M18	18" •
MX	Custom Length (specify in inches)

<b>J</b>	<b>Calibration (See Page 5)</b>
K	Type K - Thermocouple •
J	Type J - Thermocouple •
E	Type E - Thermocouple •
T	Type T - Thermocouple
S	Type S - Thermocouple
R	Type R - Thermocouple
B	Type B - Thermocouple
N	Type N - Thermocouple
L	Low Temp (-58°F to 482°F) - RTD •
H	High Temp (-328°F to 1221°F) - RTD •

<b>K</b>	<b>Sensor Type</b>
1	Single Thermocouple •
2	Duplex Thermocouple •
3	Triplex Thermocouple
A	2-Wire RTD, Single Element
B	3-Wire RTD, Single Element •
C	4-Wire RTD, Single Element
D	2-Wire RTD, Duplex Element (4 Wires Total)
E	3-Wire RTD, Duplex Element (6 Wires Total) •
F	4-Wire RTD, Duplex Element (8 Wires Total)

<b>L</b>	<b>Upgrade to Daily Premium™ Line</b>
Y	Yes (see page 17 for details as not all configurations are available) •
N	No (not available for RTDs) •

<b>M</b>	<b>Measuring Junction Type (See Page 7)</b>
1	Grounded •
2	Ungrounded •
3	Exposed
N	Not Applicable - RTD •

<b>N</b>	<b>Limits of Error (See Page 5)</b>
1	Standard Limits Thermocouple (Class 2) •
2	Special Limits Thermocouple (Class 1) <sup>3</sup> •
A	100 OHM Platinum, Alpha=0.00385 (Class A) RTD
B	100 OHM Platinum, Alpha=0.00385 (Class B) RTD •

<b>O</b>	<b>Sensor Sheath Diameter (See Page 6)</b>
1	1/8" (0.125") <sup>4</sup>
2	3/16" (0.188") <sup>5</sup>
3	1/4" (0.250") <sup>5</sup> •
4	5/16" (0.313") <sup>5</sup>
5	3/8" (0.375") <sup>5</sup> •
6	1/2" (0.500") <sup>5</sup>

<b>P</b>	<b>Sensor Sheath Material (See Page 6)</b>
304	304 SS
304L	304L SS
316	316 SS <sup>6</sup> •
316L	316L SS
310	310 SS
321	321 SS
347	347 SS
446	446 SS
I600	Inconel® 600
I800	Incoloy® 800
HASTX	Hastelloy® X
M400	Monel® 400

<b>Q</b>	<b>Calibration Options</b>
1	Report not Required •
2	212°F (100°C) with Certificate •
3	212°F (100°C) with Report
4	3-Point Calibration <sup>7</sup> with Report
5	5-Point Calibration <sup>7</sup> with Report

1. A unique and simplified item number will be generated and issued for every customized thermocouple for ease of reordering.
2. The majority of options are customizable. Please contact sales if your requirements are not listed in this catalog.
3. Includes Daily Premium™ Line.
4. Low Temp RTD is available at 1/8" and bigger.
5. High Temp RTD is available at 3/16" and bigger.
6. 316 SS is standard for RTDs.
7. Specify calibration temperature points with order.

# Model 360

## Industrial Sensor Assembly with Remote Head

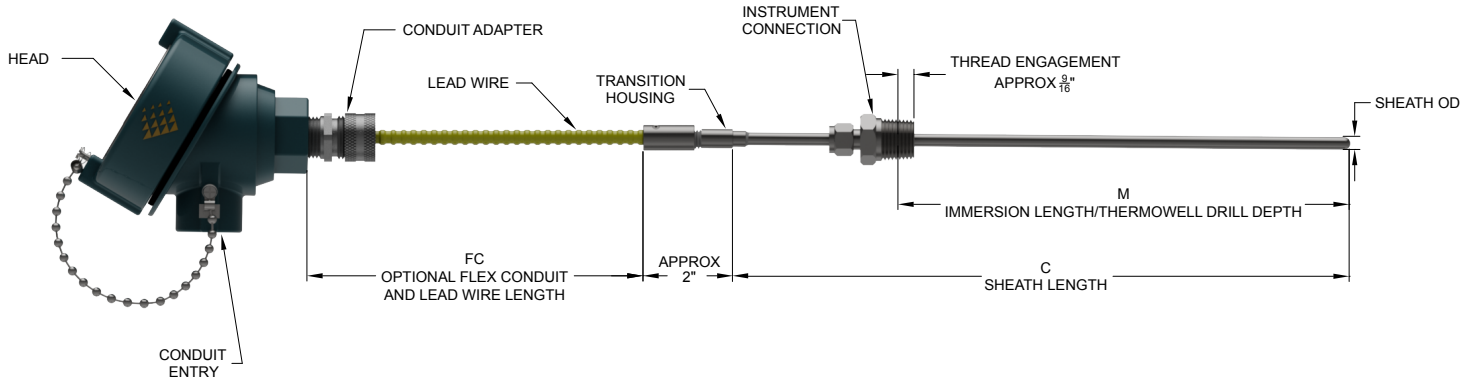

Daily Thermetrics' 360 Series Remote Industrial Sensor Assembly is a sensor probe with conductor wires that transition into lead wire in flexible conduit for remote termination into a head. This sensor is suited for use either in thermowells (see Daily Thermetrics' Thermowell Catalog) or directly in a process. All aspects of this sensor assembly are customizable, including element type, sheath metallurgy, length, connection type, and head.

I	Transition Housing
1 Housing with Adapter	
2 Housing without Adapter	
3 Flush	

J	Instrument Connection Type
1 / 2 / 3 Compression Fitting (Standard, Swagelok® or Parker manufacturer)	
4 / 5 Spring-Loaded Fitting with Retainer	
6 / 7 Spring-Loaded Compression Fitting with Retainer	
U / V Spring-Loaded Fitting with Self-Retaining Spring	
X / Y Spring-Loaded Compression Fitting with Self-Retaining Spring	



# Model 360 How to Order

EXAMPLE:

A	B	C	D	E	F	G	H	I	J	K	L	M	N	O	P	Q	R	S	T	U	V	W
360	1	1	1	6	1	2	FC36	1	1	3	3	N	M0	C12	K	1	N	2	2	5	316	1

• INDICATES COMMON SELECTION

A	Model
360	Sensor with Remote Mount Head •

B	Head Style & Material	Classification
1	Aluminum Explosion Proof (screw cover)	CI I, Div 1, Groups B,C,D NEMA 4X, IP68, Ex d ATEX, IEC, CSA, FM •
2	Aluminum Weatherproof (snap cover)	Not Applicable
3	Cast Iron Explosion Proof (screw cover)	CI I, Div 1&2, Groups B,C,D NEMA 3, 4, 7CD, 9EFG
4	Cast Iron Weatherproof (screw cover)	Not Applicable

C	Conduit Entry
1	3/4" FNPT •
2	1/2" FNPT
3	1" FNPT
4	M20x1.5

D	Conduit Adapter Material
1	Aluminum •
2	Steel

E	Type of Lead Wire
1	Solid - 24 AWG
2	Solid - 20 AWG
3	Solid - 18 AWG
4	Stranded - 24 AWG (standard for duplex thermocouples) •
5	Stranded - 22 AWG (standard for RTDs) •
6	Stranded - 20 AWG (standard for single thermocouples) •

F	Lead Wire Insulation
1	PVC Coated ANSI MC 96.1 Color Code (-40°F to 221°F) (standard for thermocouples) •
2	PVC Coated IEC 584-3 Color code (-40°F to 221°F)
3	PFA Teflon Coated (-450° to 500°F) (standard for RTDs) •
4	Fiberglass (-100° to 900°F)

G	Flexible Conduit
1	No Conduit
2	PVC Coated Stainless Steel ANSI MC 96.1 Color Code (-40°F to 221°F) •
3	PVC Coated Stainless Steel IEC 584-3 Color Code (-40°F to 221°F)
4	PFA Teflon Coated Stainless Steel (-450° to 500°F)
5	Stainless Steel with No Insulation

H	FC Dimension (Lead Wire Length)
FC36	36" •
FCXX	Custom Length (specify in inches)

I	Transition Housing
1	Housing with Adapter •
2	Housing without Adapter
3	Flush <sup>3</sup>

J	Instrument Connection Type
1	Compression Fitting •
2	Compression Fitting (Swagelok®)
3	Compression Fitting (Parker)
4	Spring-Loaded Fitting with SS Spring and Retainer
5	Spring-Loaded Fitting with Inconel® Spring and Retainer
6	Spring-Loaded Compression Fitting with SS Spring and Retainer
7	Spring-Loaded Compression Fitting with Inconel® Spring and Retainer
U	Spring-Loaded Fitting with Self-Retaining SS Spring
V	Spring-Loaded Fitting with Self-Retaining Inconel® Spring
X	Spring-Loaded Compression Fitting with Self-Retaining SS Spring
Y	Spring-Loaded Compression Fitting with Self-Retaining Inconel® Spring
N	None •

K	Instrument Connection Material
1	304 SS
2	316 SS •
3	Brass
N	None •

L	Instrument Connection Size
1	3/8" NPT
2	1/2" NPT •
3	3/4" NPT
N	None •

M	Vent Hole for Instrument Connection - Ø1/8"
Y	Yes
N	None •

N	M Dimension (Immersion Length/Thermowell Drill Depth)
M0	No Instrument Connection (set length in field) •
M6	6" •
M9	9" •
M12	12" •
M15	15" •
M18	18" •
MXX	Custom Length (specify in inches)

O	C Dimension (Sheath Length)
CS	Standard ("M" + 3") •
CXX	Custom Length (specify in inches)

P	Calibration (See Page 5)
K	Type K - Thermocouple •
J	Type J - Thermocouple •
E	Type E - Thermocouple •
T	Type T - Thermocouple
S	Type S - Thermocouple
R	Type R - Thermocouple
B	Type B - Thermocouple
N	Type N - Thermocouple
L	Low Temp (-58°F to 482°F) - RTD •
H	High Temp (-328°F to 1221°F) - RTD •

Q	Sensor Type
1	Single Thermocouple •
2	Duplex Thermocouple •
3	Triplex Thermocouple
A	2-Wire RTD, Single Element
B	3-Wire RTD, Single Element •
C	4-Wire RTD, Single Element
D	2-Wire RTD, Duplex Element (4 Wires Total)
E	3-Wire RTD, Duplex Element (6 Wires Total) •
F	4-Wire RTD, Duplex Element (8 Wires Total)

R	Upgrade to Daily Premium™ Line
Y	Yes - (see page 17 for details as not all configurations are available) •
N	No - RTD is not available in premium line •

S	Measuring Junction (See Page 7)
1	Grounded •
2	Ungrounded •
3	Exposed
N	Not Applicable - RTD •

T	Limits of Error (See Page 5)
1	Standard Limits Thermocouple (Class 2) •
2	Special Limits Thermocouple (Class 1) <sup>4</sup> •
A	100 OHM Platinum, Alpha=0.00385 (Class A) RTD
B	100 OHM Platinum, Alpha=0.00385 (Class B) RTD •

U	Sensor Sheath Diameter (See Page 6)
1	1/16" (0.0625")
2	1/8" (0.125") <sup>5</sup>
3	3/16" (0.188") <sup>6</sup>
4	1/4" (0.250") <sup>5</sup>
5	5/16" (0.313") <sup>6</sup>
6	3/8" (0.375") <sup>6</sup>
7	1/2" (0.500") <sup>6</sup>

V	Sensor Sheath Material (See Page 6)
304	304 SS
304L	304L SS
316	316 SS <sup>7</sup> •
316L	316L SS
310	310 SS
321	321 SS
347	347 SS
446	446 SS
I600	Inconel® 600
I800	Incoloy® 800
HASTX	Hastelloy® X
M400	Monel® 400

W	Calibration Options
1	Report not Required •
2	212°F (100°C) with Certificate •
3	212°F (100°C) with Report
4	3-Point Calibration <sup>8</sup> with Report
5	5-Point Calibration <sup>8</sup> with Report

1. A unique and simplified item number will be generated and issued for every customized thermocouple for ease of reordering.
2. The majority of options are customizable. Please contact sales if your requirements are not listed in this catalog.
3. Cannot be used with flexible conduit and/or diameter of sheath must be greater than 3/16".
4. Includes Daily Premium™ Line.
5. Low Temp RTD is available at 1/8" and bigger.
6. High Temp RTD is available at 3/16" and bigger.
7. 316 SS is standard for RTDs.
8. Specify calibration temperature points with order.

# Daily Premium™ Line

Daily Premium™ thermocouple featuring patented CatTracker® Technology, manufactured and offered exclusively by Daily Thermetrics

Where the tightest process control is critical, accuracy of instrumentation is paramount. Daily Premium™ thermocouples provide accuracy and precision that is up to 4x that of standard limits of error, giving engineers and operators superior control for maximizing safety and throughput within refineries. This proprietary technology is exclusively available from Daily Thermetrics, and is derived from the patented and certified SIL 3 capable CatTracker® technology.



PERFORMANCE ADVANTAGES	NON-DAILY MINERAL-INSULATED THERMOCOUPLE	DAILY STANDARD MINERAL-INSULATED THERMOCOUPLE	DAILY PREMIUM™ MINERAL-INSULATED THERMOCOUPLE
Accuracy (Type 'K')	Available in Standard & Special Limits	Special Limits <sup>1</sup>	Ultra Limits™ Greater of $\pm 1^\circ\text{F}$ or $\pm 0.25\%$
Precision (Type 'K')	No Requirements	No Requirements	$\pm 1^\circ\text{F}^2$
Drift Mitigation	None	Yes	Anti-Drift Technology™
Life	-	Up to 2x Non-Daily Thermocouple <sup>3</sup>	Up to 3-5x Non-Daily Thermocouple <sup>3</sup>

MANUFACTURING SPECIFICATIONS	NON-DAILY MINERAL-INSULATED THERMOCOUPLE	DAILY STANDARD MINERAL-INSULATED THERMOCOUPLE	DAILY PREMIUM™ MINERAL-INSULATED THERMOCOUPLE
Insulation Compaction	70%	70% min	90% min
Insulation Resistance (min)	Grounded Junctions - Unknown Ungrounded Junctions - 1 GΩ	$\geq 10 \text{ G}\Omega$	$\geq 20 \text{ G}\Omega^4$
Transition Housing	Crimped Housing	Silver-Braced Housing with Vacuum Cure	Silver-Braced Housing with Ralexian™ Technology <sup>5</sup>

1. Daily Thermetrics' U.S. and worldwide patents include USPN 8,870,455; USPN 6,599,011; USPN 6,550,963; CA 2,848,398; and CA 2,449,074. Additional patents are pending.

1. Except when raw material is not available.

2. Within Manufactured Lot.

3. In applicable installations.

4. Not including lead wire. Lead wire IR may vary.

5. Ralexian™ Transition Housing is a Daily Thermetrics proprietary moisture seal. It comes standard on all CatTracker® Probes and on the Daily Premium™ Line thermocouples with housings. The seal is function tested at extreme conditions to ensure a proper transition housing moisture seal is achieved. Only available on standard style transition housings (not including flush design).

#### Proprietary Rights

This document is the property of Daily Thermetrics & Daily Instruments Corporation and is delivered on the express condition that it and the technical data and information embodied herein are not to be used, disclosed, or reproduced in whole or in part, for any purpose without approval of Daily Thermetrics Corporation or Daily Instruments Corporation.



# Daily Thermetrics Site Turnaround (STAR™) Services

Daily Thermetrics *STAR™ Service* programs complement and leverage our technical and production capabilities to meet turnaround instrumentation demands. A STAR™ Specialist is a graduate engineer that is experienced with all Daily Thermetrics product lines and plant process temperature measurement requirements.

## **Pre-TAR Planning**

STAR™ Specialists conduct thorough pre-TAR field verifications and create inspection and replacement plans that drastically reduce the number of **discovery items** during TAR.

## **Execution**

STAR™ Specialists are highly experienced in supervising turnkey TAR temperature instrumentation inspection and replacement programs. In addition to ensuring proper inspection procedures and redesign as necessary, they also manage production and shipping to ensure no replacement items become **critical path**. STAR™ Specialists provide a direct link to all divisions of Daily Thermetrics in order to quickly provide estimates and arrange timely delivery.

## **Inspection**

Daily Thermetrics provides dedicated Level II inspectors who are specially trained in inspection of temperature measurement equipment. We offer turnkey inspection and recertification of existing temperature measurement equipment, including visual testing, PT, PMI, UT, eddy current, hydrostatic testing, and others upon request.

## **Post-TAR Close Out**

STAR™ Specialists manage all necessary documentation – from inspection reports and wake frequency analysis to full data sheets for each item inspected, redesigned, and/or replaced.

---

**From on-site technical service and turnaround support to thermowell inspection services, STAR™ Services can be customized to suit refinery TAR requirements.**

---

- PRE-TURNAROUND PLANNING
- INVENTORY EVALUATION & STANDARDIZATION
- FIELD VERIFICATION / SURVEY
- ON-SITE TECHNICAL SUPPORT
  - Troubleshooting and Field Diagnostics
  - Design and Drawings
  - Wake Frequency Analysis
- ON-SITE SALES SUPPORT
  - Estimates
  - Rush Delivery
- INSTALLATION SUPERVISION
- INSPECTION SERVICES



**A DIVISION OF DAILY THERMETRICS**



**DAILY**  
THERMETRICS



**Daily Thermetrics Corporation**

5700 Hartsdale Drive  
Houston, TX 77036 USA

+1 713.780.8600

[sales@dailyinst.com](mailto:sales@dailyinst.com)

[www.dailyinst.com](http://www.dailyinst.com)

© 2018 Daily Thermetrics Corp.